



Iron/Tones®

Top-mount/undermount single-bowl kitchen sink
K-6584

Features

- 18" (457 mm) minimum base cabinet width.
- Single bowl.
- 7-1/2" (191 mm) depth.

Material

- KOHLER® enameled cast iron.

Installation

- Top-mount or undermount.

Recommended Products/Accessories

- K-5184 Stainless steel sink rack, 12-7/8" x 14-11/16"
- K-8801 Sink drain and strainer with tailpiece
- K-8799 Sink drain and strainer basket
- K-23726 Drain treatment
- K-23725 Cast iron cleaner

Optional Products/Accessories

- K-3294 Hardwood cutting board for kitchen sinks
- K-3277 Sink basket for Undertone® and Iron/Tones® sinks
- K-11352 Disposal Flange with Stopper
- K-9000 P-Trap

Included Components

Additional Components:
52047



Codes/Standards









ASME A112.19.1/CSA B45.2

**KOHLER® Enameled Cast Iron
Kitchen and Bathroom Sink Lifetime
Limited Warranty**

See website for detailed warranty information.

Available Colors/Finishes

Color tiles intended for reference only.

Color	Code	Description
	0	White
	FF	Sea Salt™
	96	Biscuit
	NY	Dune
	95	Ice™ Grey
	58	Thunder™ Grey
	7	Black Black™
	DGB	Indigo Blue

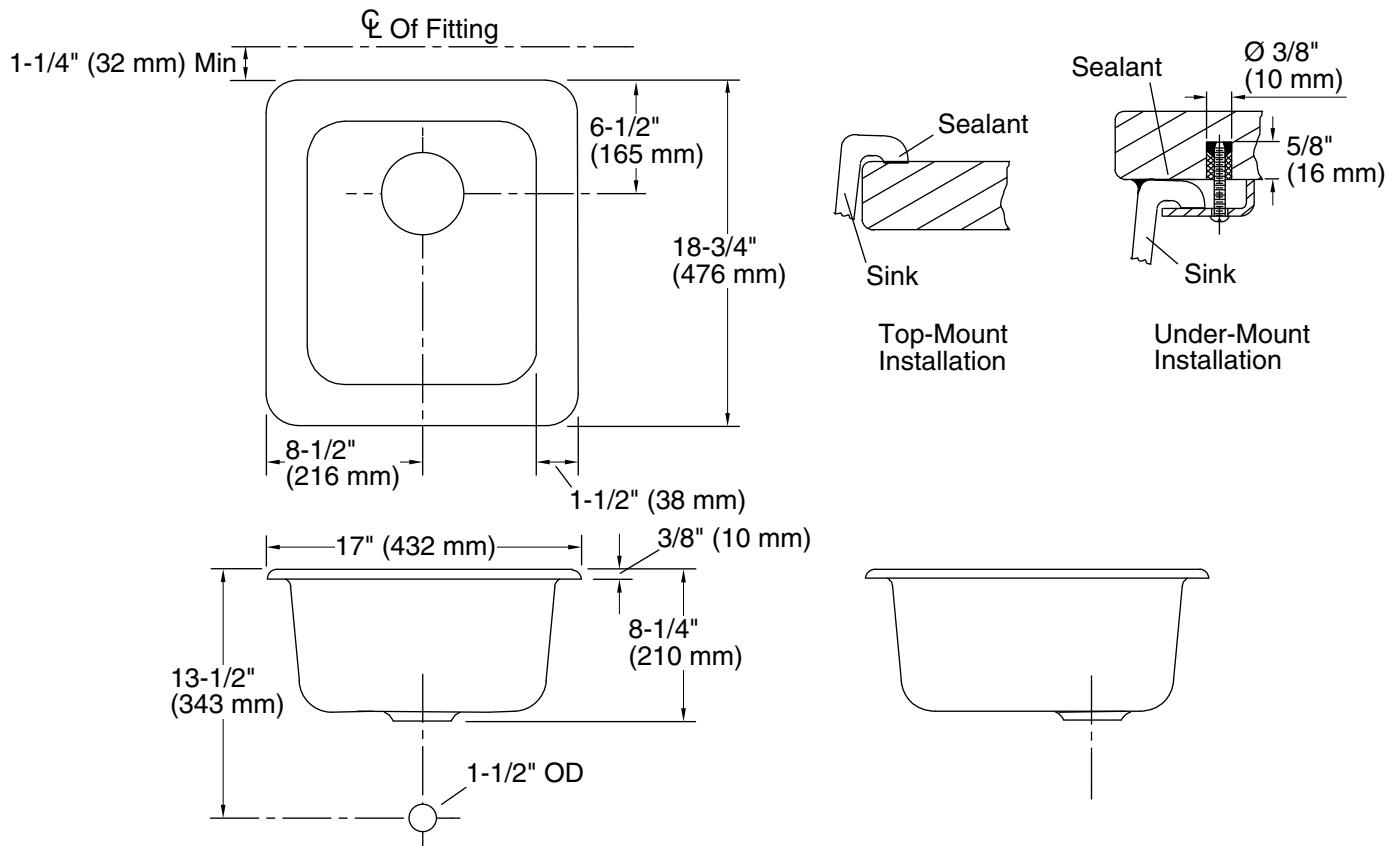

Technical Information

All product dimensions are nominal.

Bowl configuration:	Single
Installation:	Top-mount, Undermount
Min. base cabinet width:	18" (457 mm)
Bowl area:	Length: 14" (356 mm) Width: 16" (406 mm) Bowl depth: 7-1/2" (191 mm)
Drain hole:	3-7/8" (98 mm)
Template:	114332-7, required, included

Notes

Install this product according to the installation instructions.

Refer to install instructions included with fixture before beginning installation.

Supplied bowl clamp assemblies require 1" (25 mm) minimum countertop thickness. Installer must supply hardware for thinner countertops.

For multiple bowl under-mount installations, a minimum distance of 3-3/8" (86 mm) is required between bowls. Countertop supplier to determine required support.